

Current Sensor

Product Series: STK-PL/A
STK-10PL/A
STK-20PL/A
Part number: STK-32PL/A
STK-40PL/A
STK-50PL/A

Version: Ver 7.3

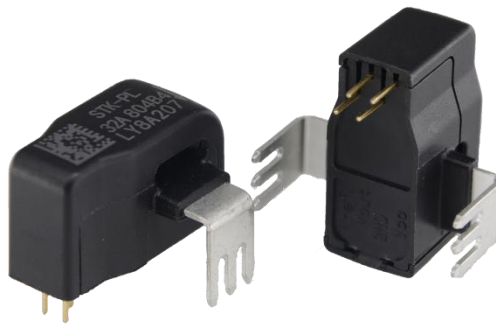

Sinomags Technology Co., Ltd

Web site: www.sinomags.com

CONTENT

1.	Summary	2
2.	STK-10PL/A Electrical performance	4
3.	STK-20PL/A Electrical performance	5
4.	STK-32PL/A Electrical performance	6
5.	STK-40PL/A Electrical performance	7
6.	STK-50PL/A Electrical performance	8
7.	Output voltage VS primary current	9
8.	Maximum continues DC current	11
9.	Accuracy at room temperature	12
10.	Accuracy over temperature	13
11.	Frequency response and bandwidth	14
12.	Step response time	15
13.	Frequency delay performance	15
14.	Recommended PCB layout	16
15.	Dimension & Pin definitions	17
16.	Appendix: typical application circuit	18

1. Summary

The STK-PL/A series is based on TMR (Tunneling-Magnetoresistance) technology and open-loop design. It is suitable for DC, AC, pulsed and any kind of irregular current measurement under the isolated conditions. The nominal current range of the STK-PL/A current sensor consists of 10 A, 20 A, 32 A, 40 A, 50 A.

Typical applications

- PV combiner box
- PV inverter (MPPT & AC)
- motor driver controller
- SMPS & UPS
- Battery management system

Standards

- EN50178:1997
- IEC 61010-1:2010
- IEC 61326-1:2012

General parameter

Parameter	Symbol	Unit	Value
Working temperature	T _A	°C	-40 ~ 105
Storage temperature	T _{stg}	°C	-40 ~ 105
Mass	m	g	10
Current line impedance	Z	mΩ	0.2
Current line temperature rise	Tr	°C	110

Absolute maximum rating

Parameter	Symbol	Unit	Value
Supply voltage (non-destructive)	V _C	V	6.0
ESD rating (HBM)	U _{ESD}	kV	4
ESD rating (CDM)	U _{CDM}	kV	1.5

Remark: the unrecoverable damage may occur when the product works on the conditions over the absolute maximum ratings. Long-time working on the absolute maximum ratings may cause the degradation on performance and reliability.

Ratings

Parameter	Symbol	Unit	Value
Primary involved potential		V AC/DC	600
Ambient operating temperature	T_A	°C	105
Primary current	I_p	A	According to series primary current
Secondary supply voltage	U_c	V DC	5
Output voltage	V_out	V	0.1 ~ 4.9

Isolation parameter

Parameter	Symbol	Unit	Value	Comment
RMS voltage for AC test 50Hz/1 min	U _d	kV	5	
Impulse withstand voltage 1.2/50μs	Ū _w	kV	8	
Clearance distance (pri. -sec)	d _{Cl}	mm	8	Shortest distance through air
Creepage distance (pri. -sec)	d _{Cp}	mm	8	Shortest path along device body
Case material			V0 according to UL 94	
Application example		V	600	Reinforced insulation, CAT III, PD 2, non uniform field according EN 50178, IEC 61010
Application example		V	1000	Basic insulation, CAT III, PD 2, non uniform field according EN 50178, IEC 61010
Application example		V	1500	Basic insulation, CAT III, PD 2, according to IEC 62109-1 Altitude ≤ 3000 m
Application example		V	600	CAT III, PD 2, according to UL 508

2. STK-10PL/A Electrical performance

Condition: $T_A = 25^\circ\text{C}$, $V_{cc} = 5\text{ V}$ (Except special instructions)

Parameter	Symbol	Unit	Min	Typ	Max	Comment
Primary nominal current rms	I_{pn}	A		10		
Primary current measuring range	I_{pm}	A	-25		25	
Supply voltage	V_{cc}	V	4.75	5	5.25	
Current consumption	I_{cc}	mA		5	10	
Reference voltage	V_{ref}	V	2.48	2.5	2.52	Output function
Rated output voltage	V_{FS}	V		0.8		$(V_{out} - V_{ref}) @ I_{pn}$
Internal output resistance	R_{out}	Ω		1		Output
Internal output resistance	R_{ref}	Ω		1		Output
Quiescent voltage	V_{off}	V	2.48	2.5	2.52	$V_{out} @ 0\text{ A}$
Electrical offset voltage	V_{oe}	mV	-10		10	$(V_{out} - V_{ref}) @ 0\text{ A}$
Temperature drift of V_{oe}	V_{oe_TRange}	mV	-8		8	$-40^\circ\text{C} \sim 105^\circ\text{C}$
Magnetic offset current	I_{om}	A	-0.25		0.25	@ $\pm 10 \times I_{pn}$
Theoretical gain	G_{th}	mV/A		80		800 mV @ I_{pn}
Error of gain	Err_G	% G_{th}		± 0.5		Trimmed in the factory @ 25°C
Temperature drift of gain	G_{TR}	% G_{th}	-1.0		1.0	$-40^\circ\text{C} \sim 105^\circ\text{C}$
Rated linearity error	$Non-L_{pn}$	% I_{pn}	-0.5		0.5	$\pm I_{pn}$
Linearity error @ I_{pm}	$Non-L_{pm}$	% I_{pm}	-1		1	$\pm I_{pm}$
Reaction time	t_{ra}	μs		0.5	1	@ 10% of I_{pn}
Step response time	t_{res}	μs		1.5	2	@ 90% of I_{pn}
Delay time	t_{delay}	μs		1		400 kHz sine wave
Frequency bandwidth (-3dB)	BW	kHz		400		No RC circuit
Output voltage noise	V_{noise}	mVpp		15		
DC ~ 100 kHz				25		
Accuracy @ 25°C	X	% of I_{pn}	-1		1	@ 25°C
Accuracy @ $-40^\circ\text{C} \sim 105^\circ\text{C}$	X_{TRange}	% of I_{pn}	-2		2	$-40^\circ\text{C} \sim 105^\circ\text{C}$

3. STK-20PL/A Electrical performance

Condition: $T_A = 25^\circ\text{C}$ $V_{cc} = 5\text{ V}$ (Except special instructions)

Parameter	Symbol	Unit	Min	Typ	Max	Comment
Primary nominal current rms	I_{pn}	A		20		
Primary current measuring range	I_{pm}	A	-50		50	
Supply voltage	V_{cc}	V	4.75	5	5.25	
Current consumption	I_{cc}	mA		5	10	
Reference voltage	V_{ref}	V	2.48	2.5	2.52	Output function
Rated output voltage	V_{FS}	V		0.8		$(V_{out} - V_{ref}) @ I_{pn}$
Internal output resistance	R_{out}	Ω		1		Output
Internal output resistance	R_{ref}	Ω		1		Output
Quiescent voltage	V_{off}	V	2.48	2.5	2.52	$V_{out} @ 0\text{ A}$
Electrical offset voltage	V_{oe}	mV	-10		10	$(V_{out} - V_{ref}) @ 0\text{ A}$
Temperature drift of V_{oe}	V_{oe_TRange}	mV	-8		8	$-40^\circ\text{C} \sim 105^\circ\text{C}$
Magnetic offset current	I_{om}	A	-0.25		0.25	@ $\pm 10 \times I_{pn}$
Theoretical gain	G_{th}	mV/A		40		800 mV @ I_{pn}
Error of gain	Err_G	% G_{th}		± 0.5		Trimmed in the factory @ 25°C
Temperature drift of gain	G_{TR}	% G_{th}	-1.0		1.0	$-40^\circ\text{C} \sim 105^\circ\text{C}$
Rated linearity error	$Non-L_{pn}$	% I_{pn}	-0.5		0.5	$\pm I_{pn}$
Linearity error @ I_{pm}	$Non-L_{pm}$	% I_{pm}	-1		1	$\pm I_{pm}$
Reaction time	t_{ra}	μs		0.5	1	@ 10% of I_{pn}
Step response time	t_{res}	μs		1.5	2	@ 90% of I_{pn}
Delay time	t_{delay}	μs		1		400 kHz sine wave
Frequency bandwidth (-3dB)	BW	kHz		400		No RC circuit
Output voltage noise	V_{noise}	mVpp		12		
DC ~ 10 kHz				17		
DC ~ 100 kHz						
Accuracy @ 25°C	X	% of I_{pn}	-1		1	@ 25°C
Accuracy @ $-40^\circ\text{C} \sim 105^\circ\text{C}$	X_{TRange}	% of I_{pn}	-2		2	$-40^\circ\text{C} \sim 105^\circ\text{C}$

4. STK-32PL/A Electrical performance

Condition: $T_A = 25^\circ\text{C}$ $V_{cc} = 5\text{ V}$ (Except special instructions)

Parameter	Symbol	Unit	Min	Typ	Max	Comment
Primary nominal current rms	I _{pn}	A		32		
Primary current measuring range	I _{pm}	A	-80		80	
Supply voltage	V _{cc}	V	4.75	5	5.25	
Current consumption	I _{cc}	mA		5	10	
Reference voltage	V _{ref}	V	2.48	2.5	2.52	Output function
Rated output voltage	V _{FS}	V		0.8		(V _{out} - V _{ref}) @ I _{pn}
Internal output resistance	R _{out}	Ω		1		Output
Internal output resistance	R _{ref}	Ω		1		Output
Quiescent voltage	V _{off}	V	2.48	2.5	2.52	V _{out} @ 0 A
Electrical offset voltage	V _{oe}	mV	-10		10	(V _{out} - V _{ref}) @ 0 A
Temperature drift of V _{oe}	V _{oe} _TRange	mV	-8		8	-40°C ~ 105°C
Magnetic offset current	I _{om}	A	-0.25		0.25	@ ±10 x I _{pn}
Theoretical gain	G _{th}	mV/A		25		800 mV @ I _{pn}
Error of gain	Err_G	%G _{th}		±0.5		Trimmed in the factory @ 25°C
Temperature drift of gain	G _{TR}	%G _{th}	-1.0		1.0	-40°C ~ 105°C
Rated linearity error	Non-L _{pn}	%I _{pn}	-0.5		0.5	±I _{pn}
Linearity error @ I _{pm}	Non-L _{pm}	%I _{pm}	-1.0		1.0	±I _{pm}
Reaction time	t _{ra}	μs		0.5	1	@ 10% of I _{pn}
Step response time	t _{res}	μs		1.5	2	@ 90% of I _{pn}
Delay time	t _{delay}	μs		1		400 kHz sine wave
Frequency bandwidth (-3dB)	BW	kHz		400		No RC circuit
Output voltage noise	V _{noise}	mVpp		12		
DC ~ 10 kHz				17		
DC ~ 100 kHz						
Accuracy @ 25°C	X	% of I _{pn}	-1		1	@ 25°C
Accuracy @ -40°C ~ 105°C	X_TRange	% of I _{pn}	-2		2	-40°C ~ 105°C

5. STK-40PL/A Electrical performance

Condition: $T_A = 25^\circ\text{C}$ $V_{cc} = 5\text{ V}$ (Except special instructions)

Parameter	Symbol	Unit	Min	Typ	Max	Comment
Primary nominal current rms	I_{pn}	A		40		
Primary current measuring range	I_{pm}	A	-100		100	
Supply voltage	V_{cc}	V	4.75	5	5.25	
Current consumption	I_{cc}	mA		5	10	
Reference voltage	V_{ref}	V	2.48	2.5	2.52	Output function
Rated output voltage	V_{FS}	V		0.8		$(V_{out} - V_{ref}) @ I_{pn}$
Internal output resistance	R_{out}	Ω		1		Output
Internal output resistance	R_{ref}	Ω		1		Output
Quiescent voltage	V_{off}	V	2.48	2.5	2.52	$V_{out} @ 0\text{ A}$
Electrical offset voltage	V_{oe}	mV	-10		10	$(V_{out} - V_{ref}) @ 0\text{ A}$
Temperature drift of V_{oe}	V_{oe_TRange}	mV	-8		8	$-40^\circ\text{C} \sim 105^\circ\text{C}$
Magnetic offset current	I_{om}	A	-0.25		0.25	@ $\pm 10 \times I_{pn}$
Theoretical gain	G_{th}	mV/A		20		800 mV @ I_{pn}
Error of gain	Err_G	% G_{th}		± 0.5		Trimmed in the factory @ 25°C
Temperature drift of gain	G_{TR}	% G_{th}	-1.0		1.0	$-40^\circ\text{C} \sim 105^\circ\text{C}$
Rated linearity error	$Non-L_{pn}$	% I_{pn}	-0.5		0.5	$\pm I_{pn}$
Linearity error @ I_{pm}	$Non-L_{pm}$	% I_{pm}	-1		1	$\pm I_{pm}$
Reaction time	t_{ra}	μs		0.5	1	@ 10% of I_{pn}
Step response time	t_{res}	μs		1.5	2	@ 90% of I_{pn}
Delay time	t_{delay}	μs		1		400 kHz sine wave
Frequency bandwidth (-3dB)	BW	kHz		400		No RC circuit
Output voltage noise DC ~ 10 kHz DC ~ 100 kHz	V_{noise}	mVpp		10 15		
Accuracy @ 25°C	X	% of I_{pn}	-1		1	@ 25°C
Accuracy @ $-40^\circ\text{C} \sim 105^\circ\text{C}$	X_{TRange}	% of I_{pn}	-2		2	$-40^\circ\text{C} \sim 105^\circ\text{C}$

6. STK-50PL/A Electrical performance

Condition: $T_A = 25^\circ\text{C}$ $V_{cc} = 5\text{ V}$ (Except special instructions)

Parameter	Symbol	Unit	Min	Typ	Max	Comment
Primary nominal current rms	I_{pn}	A		50		
Primary current measuring range	I_{pm}	A	-125		125	
Supply voltage	V_{cc}	V	4.75	5	5.25	
Current consumption	I_{cc}	mA		5	10	
Reference voltage	V_{ref}	V	2.48	2.5	2.52	Output function
Rated output voltage	V_{FS}	V		0.8		$(V_{out} - V_{ref}) @ I_{pn}$
Internal output resistance	R_{out}	Ω		1		Output
Internal output resistance	R_{ref}	Ω		1		Output
Quiescent voltage	V_{off}	V	2.48	2.5	2.52	$V_{out} @ 0\text{ A}$
Electrical offset voltage	V_{oe}	mV	-10		10	$(V_{out} - V_{ref}) @ 0\text{ A}$
Temperature drift of V_{oe}	V_{oe_TRange}	mV	-8		8	$-40^\circ\text{C} \sim 105^\circ\text{C}$
Magnetic offset current	I_{om}	A	-0.25		0.25	@ $\pm 10 \times I_{pn}$
Theoretical gain	G_{th}	mV/A		16		800 mV @ I_{pn}
Error of gain	Err_G	% G_{th}		± 0.5		Trimmed in the factory @ 25°C
Temperature drift of gain	G_{TR}	% G_{th}	-1.0		1.0	$-40^\circ\text{C} \sim 105^\circ\text{C}$
Rated linearity error	$Non-L_{pn}$	% I_{pn}	-0.5		0.5	$\pm I_{pn}$
Linearity error @ I_{pm}	$Non-L_{pm}$	% I_{pm}	-1.5		1.5	$\pm I_{pm}$
Reaction time	t_{ra}	μs		0.5	1	@ 10% of I_{pn}
Step response time	t_{res}	μs		1.5	2	@ 90% of I_{pn}
Delay time	t_{delay}	μs		1		400 kHz sine wave
Frequency bandwidth (-3dB)	BW	kHz		400		No RC circuit
Output voltage noise	V_{noise}	mVpp		10		
DC ~ 10 kHz				15		
DC ~ 100 kHz						
Accuracy @ 25°C	X	% of I_{pn}	-1		1	@ 25°C
Accuracy @ $-40^\circ\text{C} \sim 105^\circ\text{C}$	X_{TRange}	% of I_{pn}	-2		2	$-40^\circ\text{C} \sim 105^\circ\text{C}$

7. Output voltage VS primary current

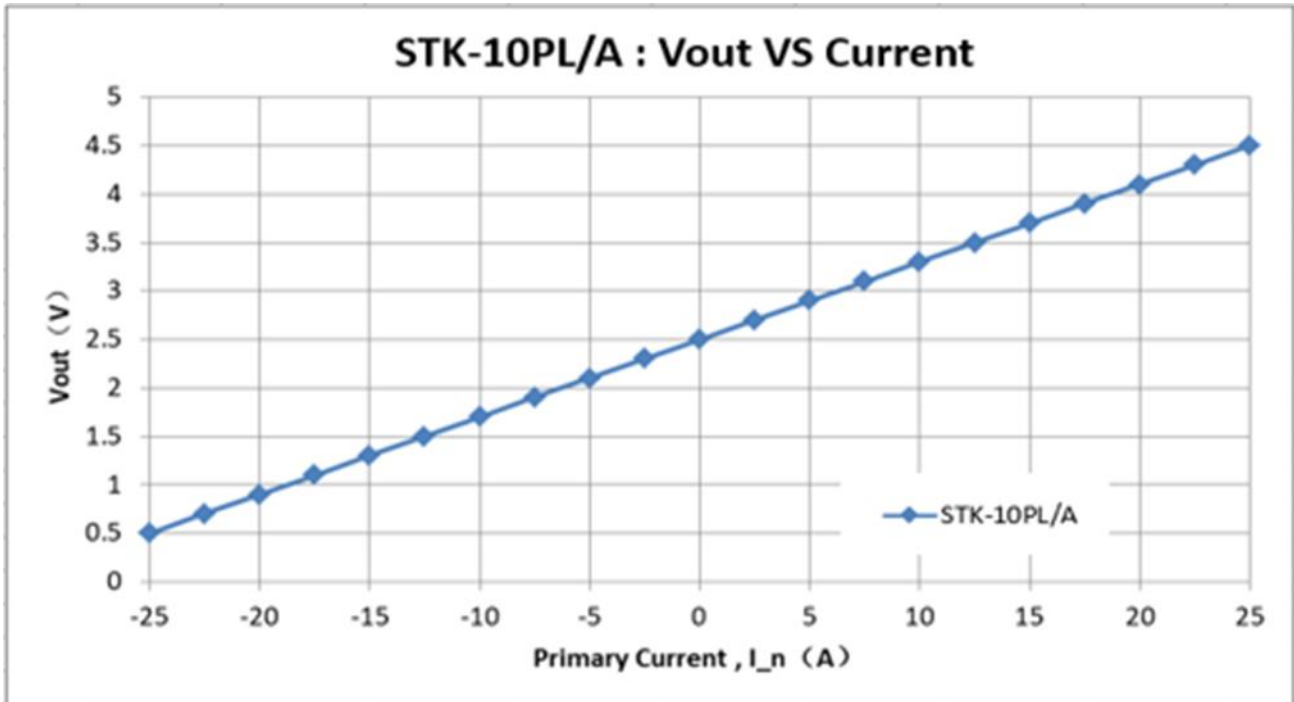

The dependence of Vout of STK-10PL/A on the primary current.

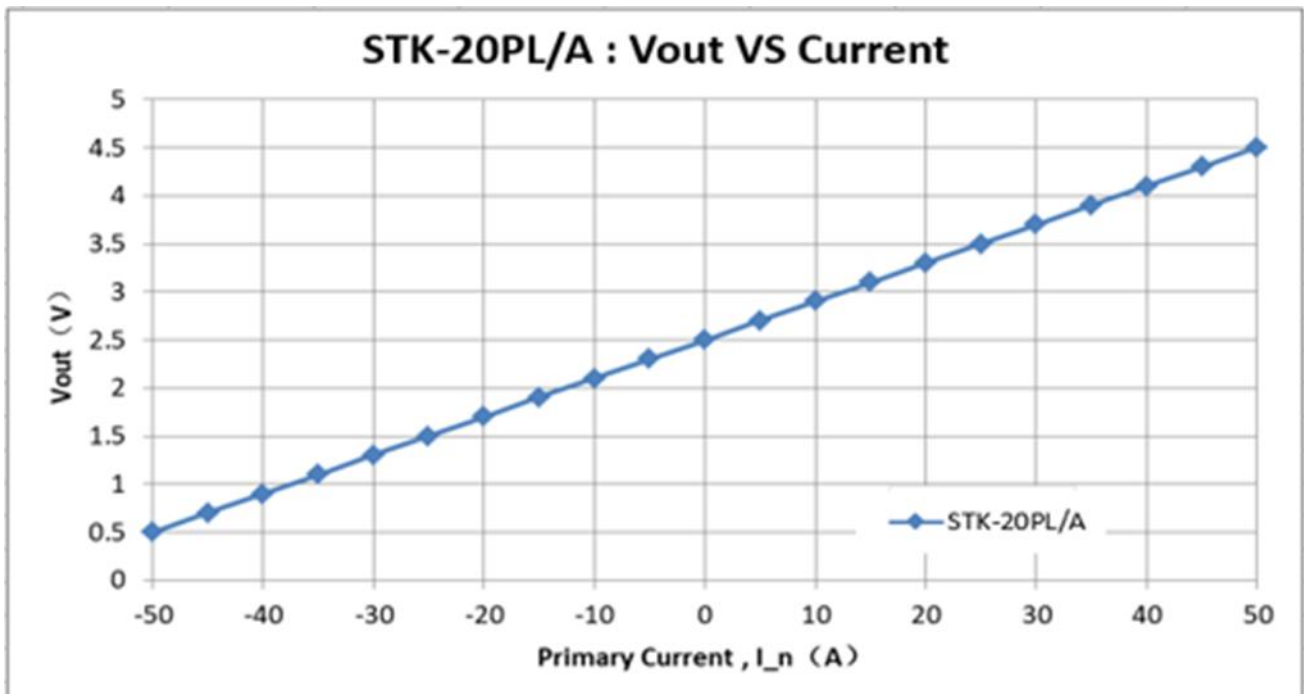

The dependence of Vout of STK-20PL/A on the primary current.

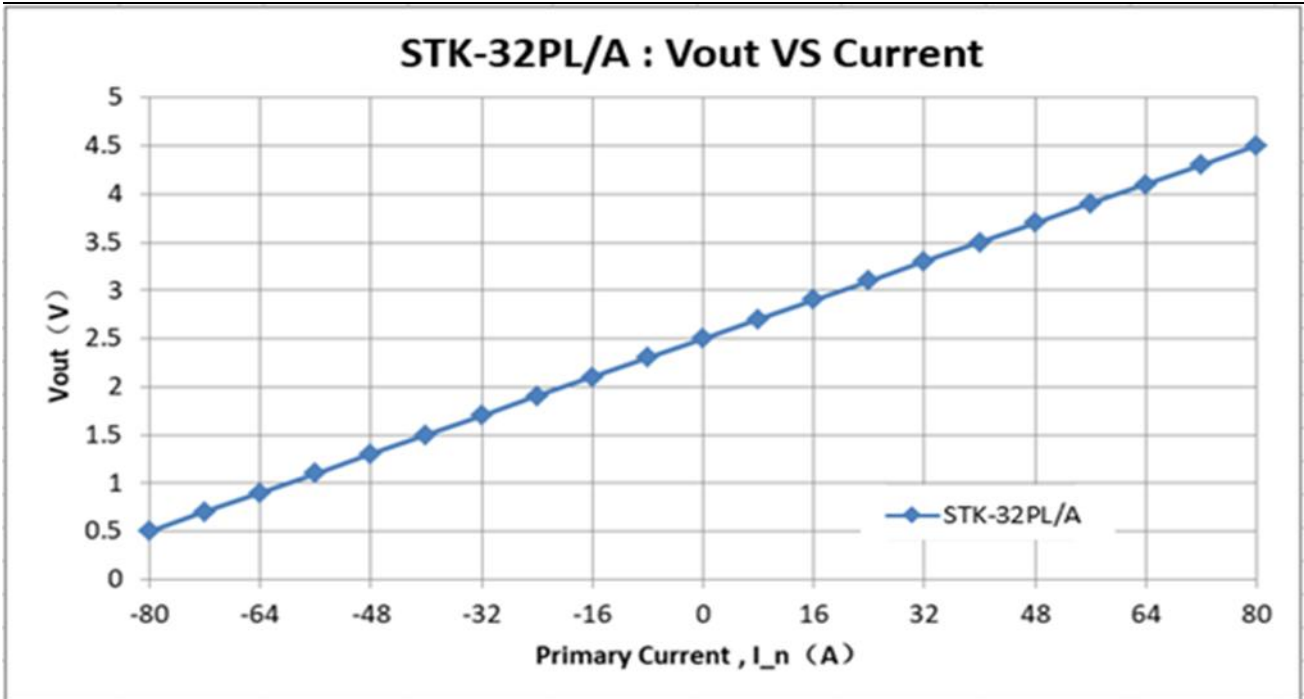

The dependence of Vout of STK-32PL/A on the primary current.

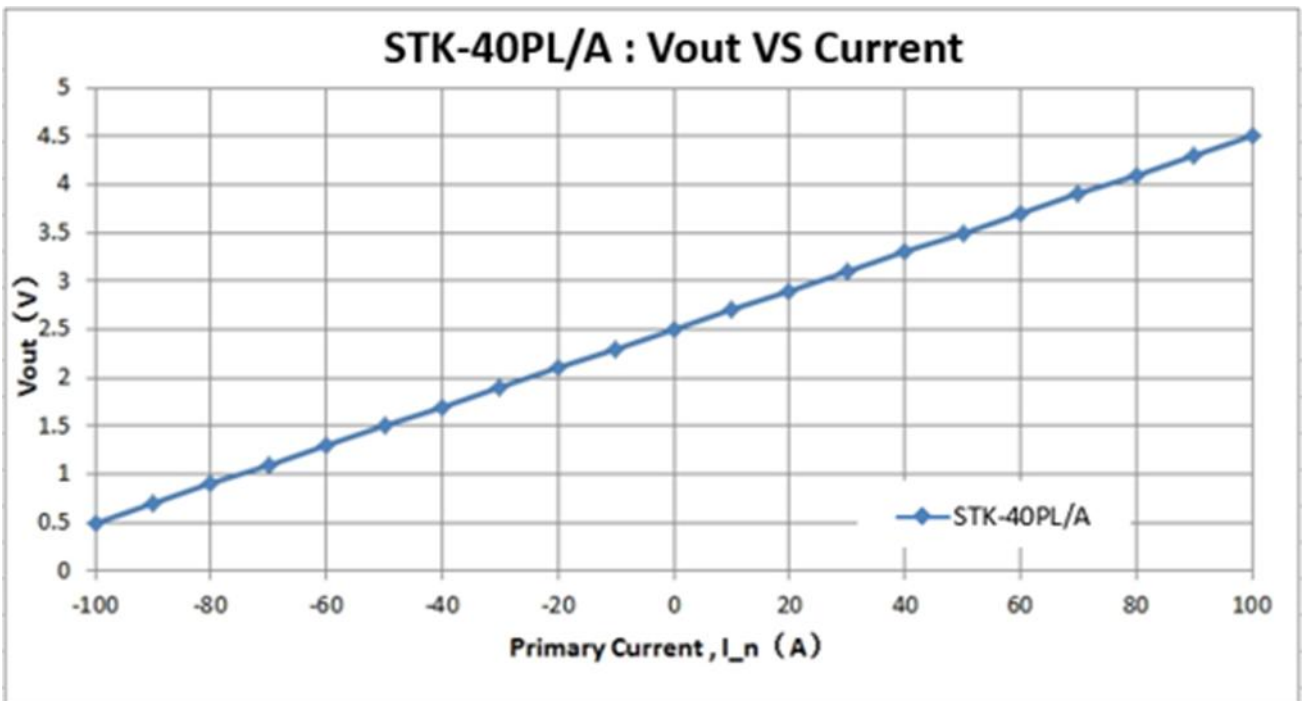

The dependence of Vout of STK-40PL/A on the primary current.

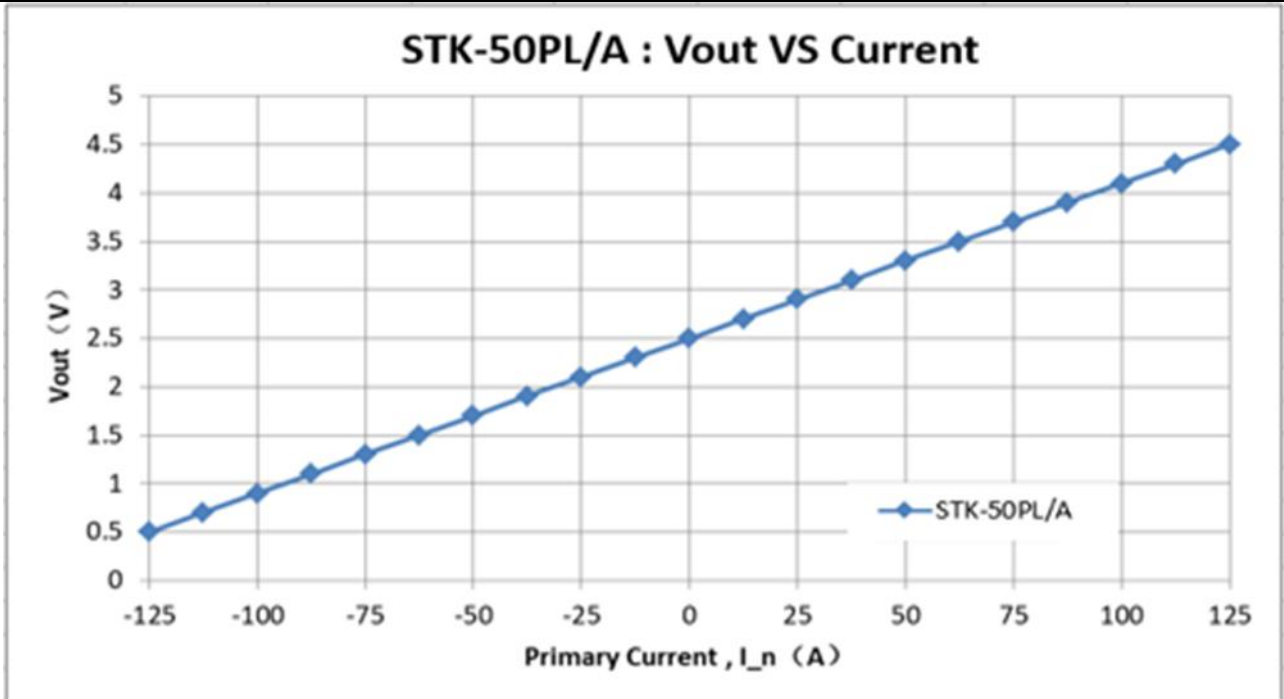

The dependence of Vout of STK-50PL/A on the primary current.

8. Maximum continues DC current

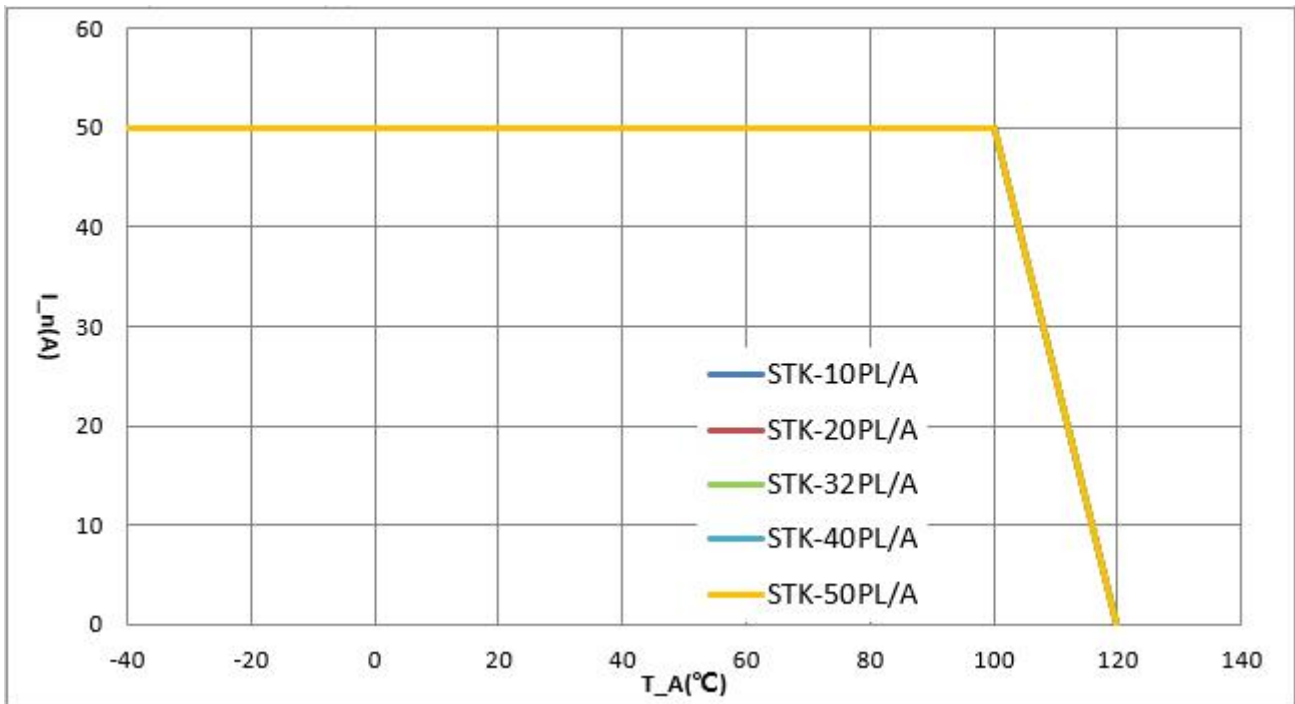

The dependence of maximum continues current of STK-PL/A current on the working temperature.

9. Accuracy at room temperature

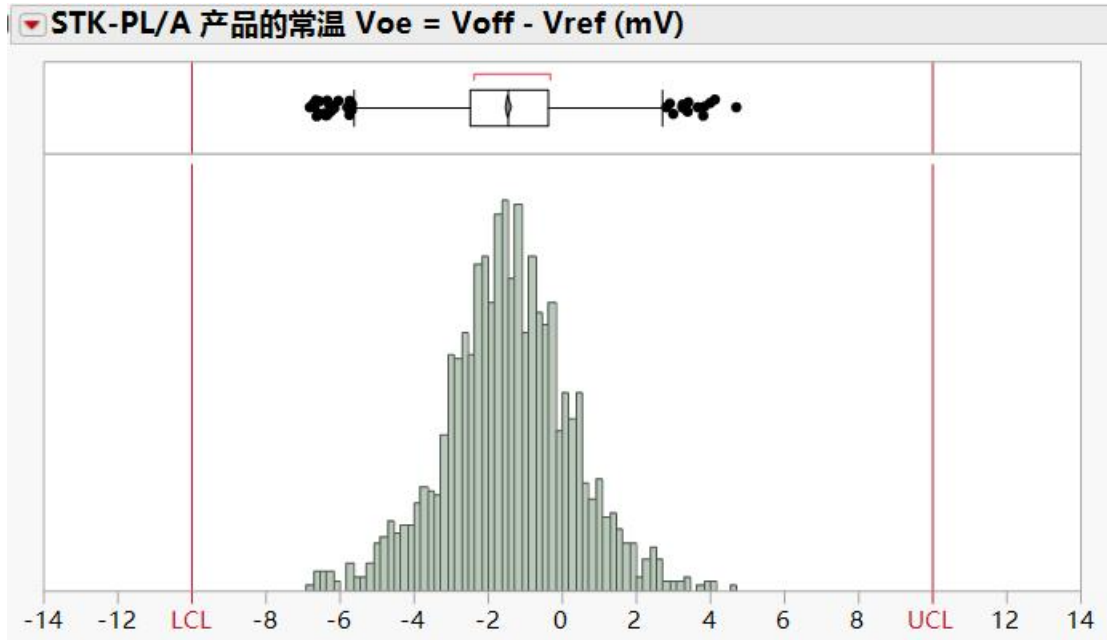

The distribution V_{oe} of STK-PL/A current sensor at 25°C.

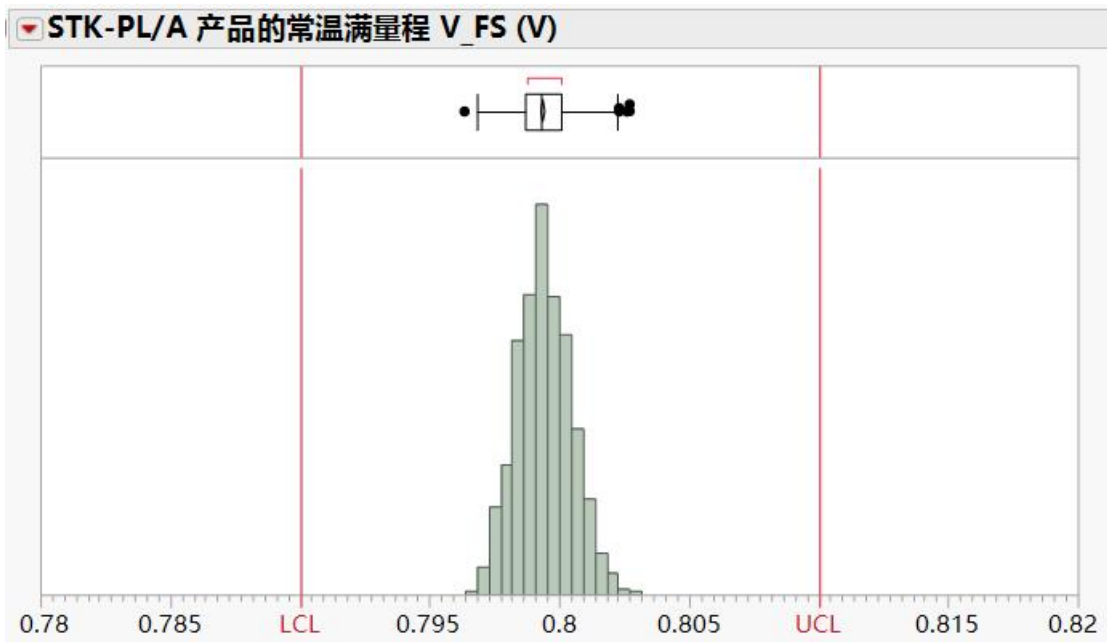

The distribution of V_{FS} OF STK-PL/A current sensor at 25°C.

10. Accuracy over temperature

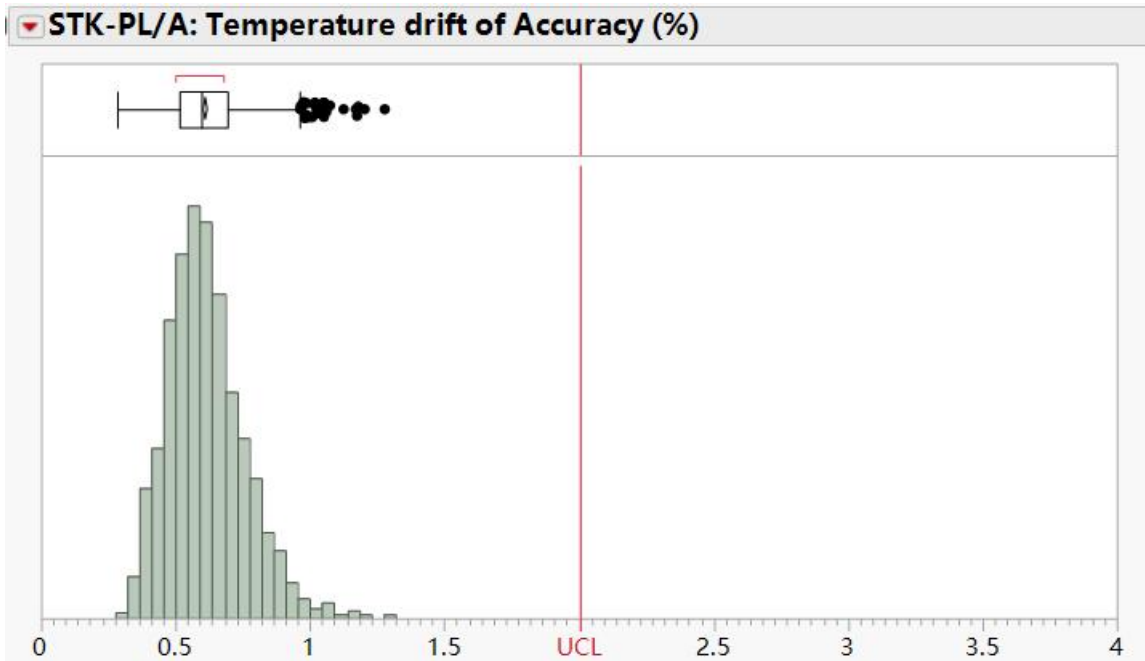

The distribution of temperature drift of accuracy, compared with room temperature, over the temperature range from -40 deg.C to 105 deg.C.

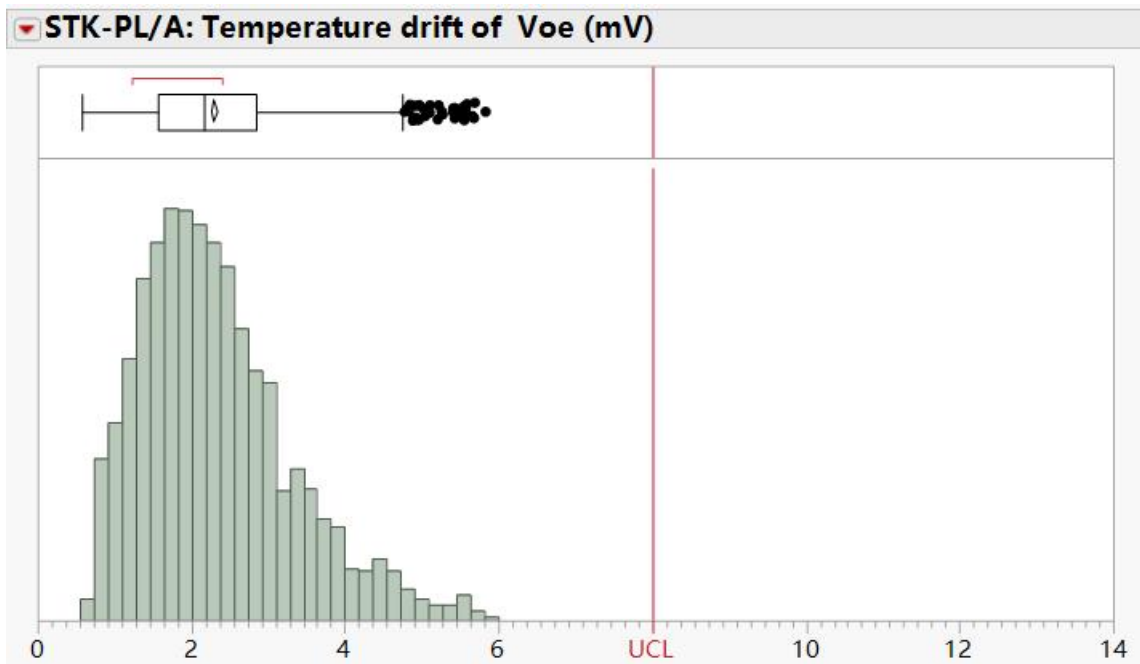

The distribution of temperature drift of Voe, compared with room temperature, over the temperature range from -40 deg.C to 105 deg.C.

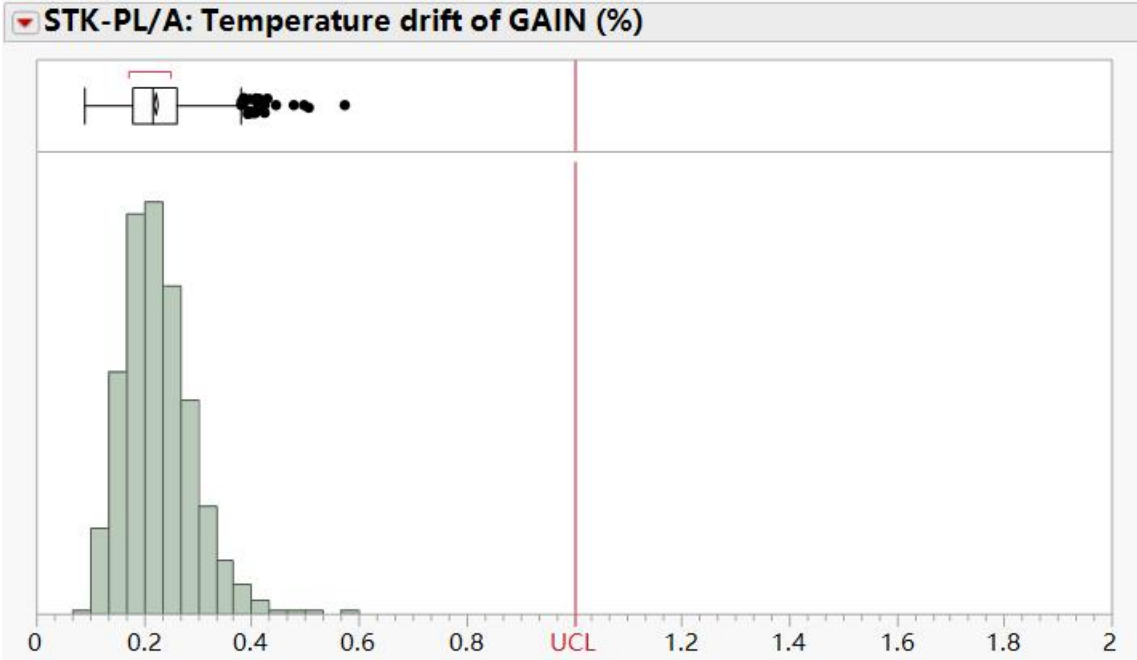

The distribution of temperature drift of GAIN, compared with room temperature, over the temperature range from -40 deg.C to 105 deg.C.

11. Frequency response and bandwidth

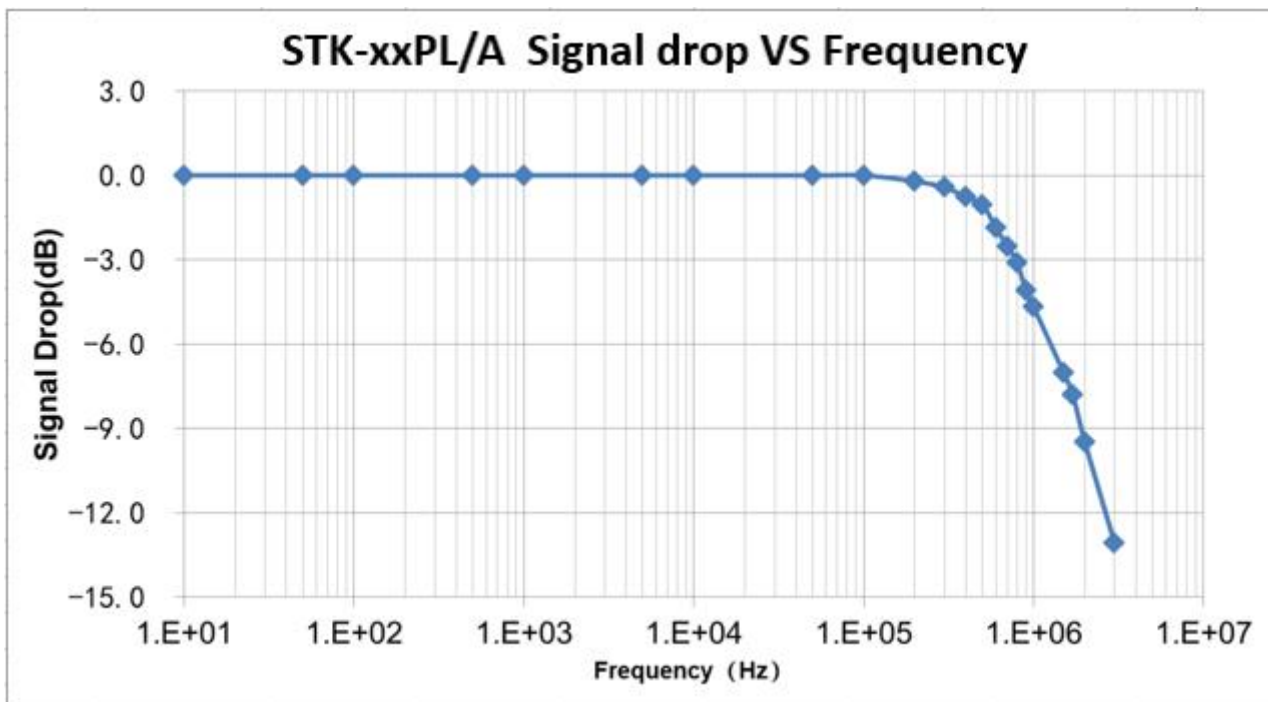

The frequency bandwidth of STK-PL/A series current sensor. The bandwidth of current sensor is DC ~ 400 kHz (-3dB).

12. Step response time

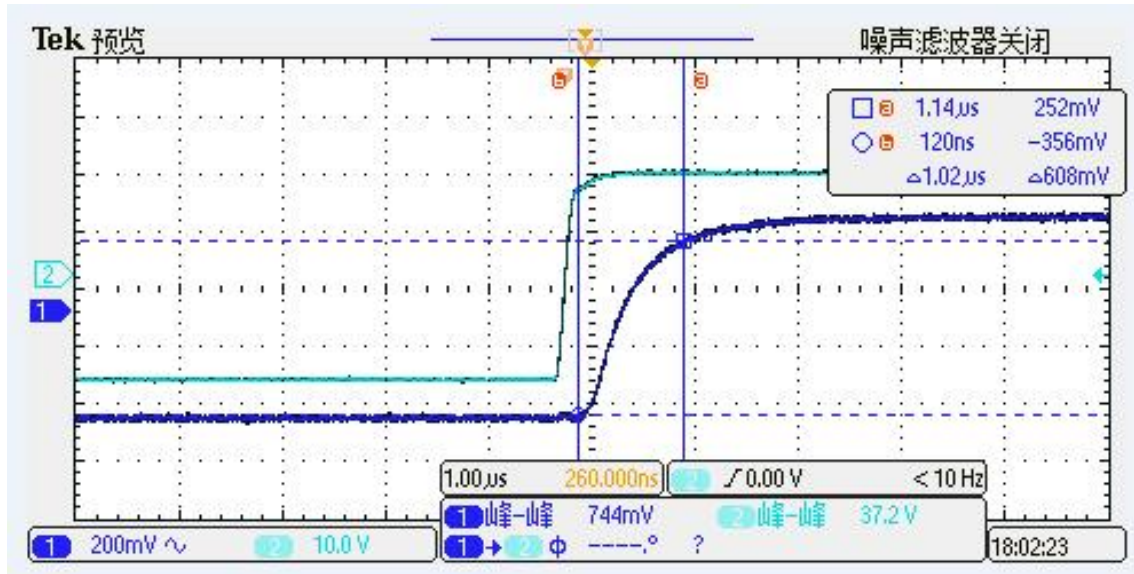

The typical frequency response of STK-xxPL/A current sensor. The response time from 90% of the primary current (light blue) to 90% of the secondary output (dark blue) is less than 1.5 μs

13. Frequency delay performance

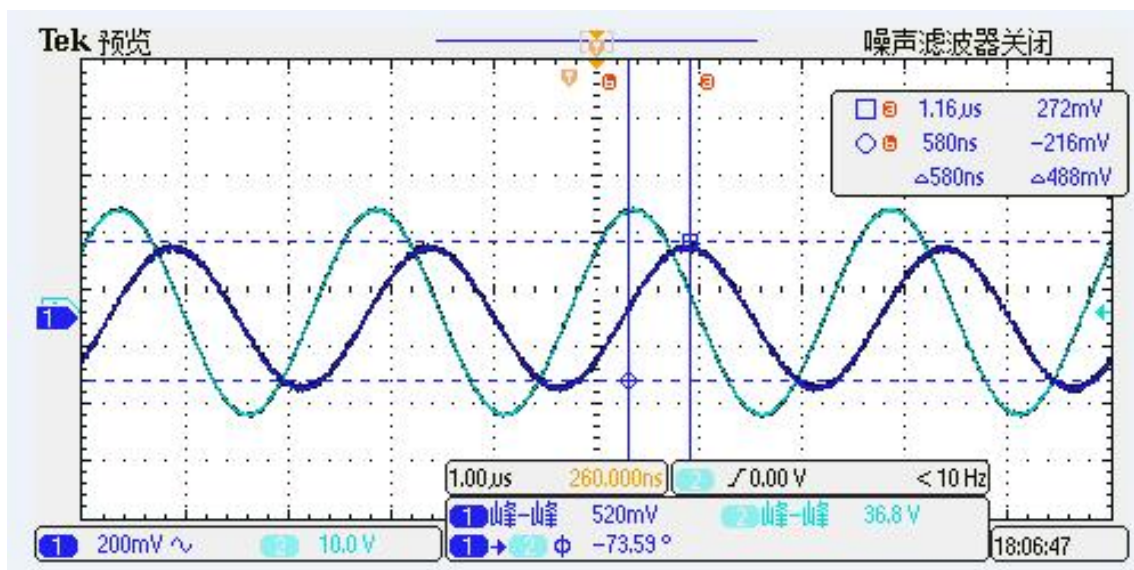

When testing 400 kHz sine wave, the typical result of STK-xxPL/A current sensor's output. The response time from the primary current (light blue) to the secondary output (dark blue) is less than 1 μs.

14. Recommended PCB layout

Installation of view: overlooking (unit: mm)

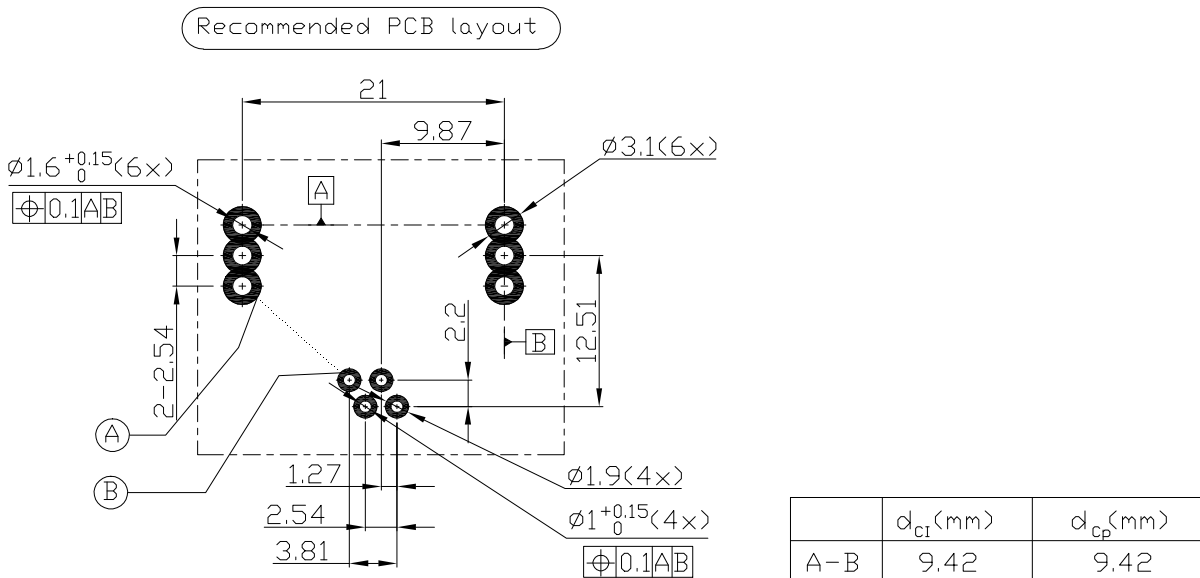

1. Installing angle: Overlook (observe from the side of installing transducer)
2. Recommended bore diameter of primary current line, (diameter of primary current $\times 1.2$) mm
3. Recommended bore diameter of secondary current line, (diameter of secondary current $\times 1.2$) mm
4. The maximum thickness of PCB is 2.5 mm
5. The curve of wave soldering: $260^{\circ}\text{C} \times 10 \text{ s}$



Security:

This current sensor must be used in limited-energy secondary circuit according to IEC 61010-1.

- This current sensor must be used in electric/electronic equipment with respect to appliance standards and safety requirement in accordance with the manufacture's operating instructions;
- When operating the current sensor, certain parts of the module can carry hazardous voltage;
- Failure to wiring as shown in the diagram will damage the current sensor;
- Ignoring this warning can lead to serious consequences.
- A protective housing or a additional shield could be used.
- Main supply must be able to disconnected.

15. Dimension & Pin definitions

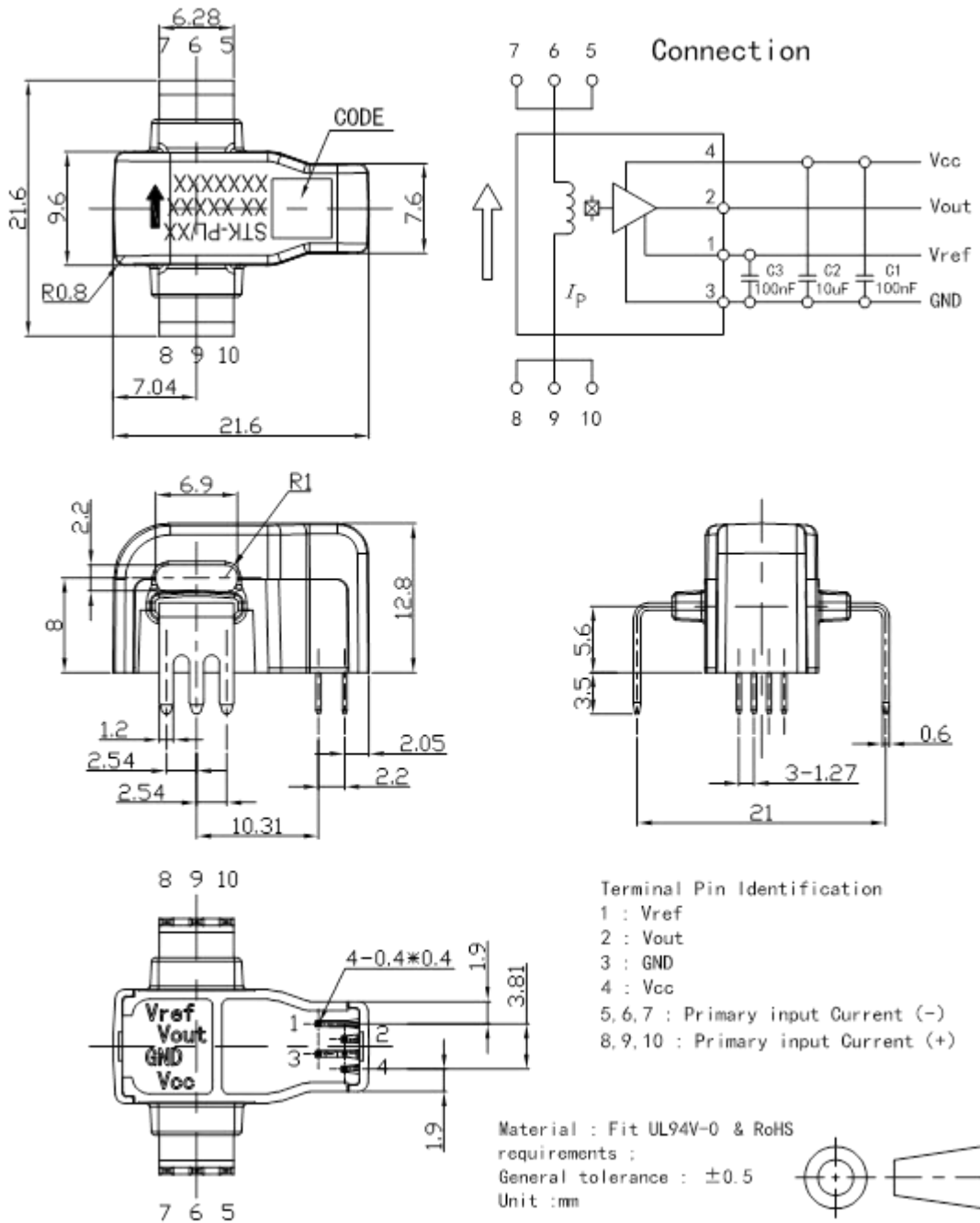

16. Appendix: typical application circuit

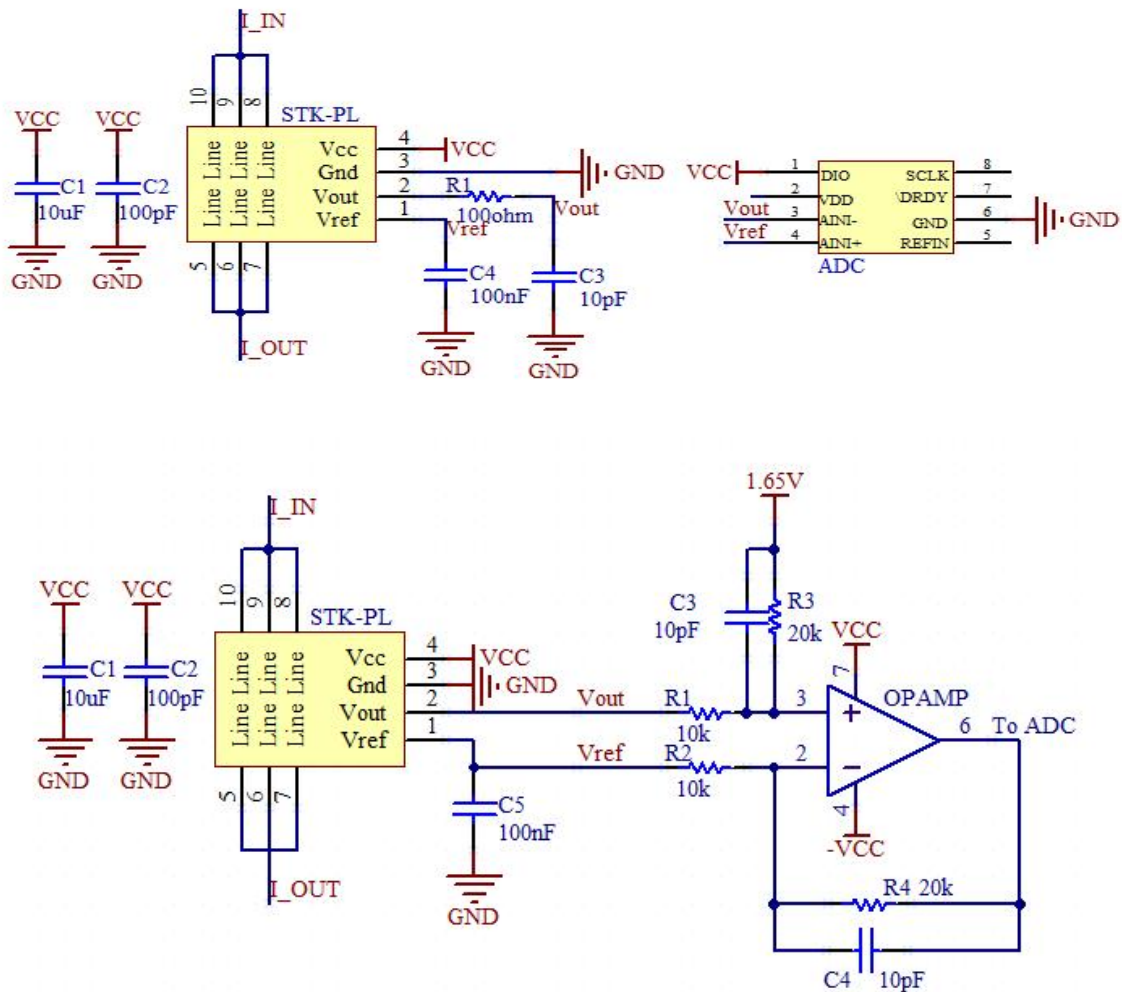

R3 (kohm)	C3 (pF)	Theoretical -3dB $f = 1/(2\pi RC)$ (kHz)	Measured -3dB (kHz)
20	20	398	~ 400
20	81	98	~ 100
20	810	10	~ 10

The frequency characteristics of STK_PL/A series current sensor are not affected by the R-C setting (according to recommended R-C setting), therefore the active filter circuit or R-C circuit can be applied to modulate the sensor's frequency characteristics.

The signal input to ADC is $1.65 + R4/R2 * (Vout - Vref)$ with the conditions: $R1 = R2, R3 = R4, C3 = C4$.