

## CURRENT SENSOR

PRODUCT SERIES: SFG-X.XCPL/A

PRODUCT PART NUMBER: SFG-0.3CPL/A4

REVISION: Ver 1.0



---

## CONTENT

1.	Description .....	2
2.	Absolute parameter .....	3
3.	Electrical data .....	4
4.	Application information .....	5
5.	Dimensions (in mm) .....	7

## 1. Description

### Features

- High and low level output
- Single supply voltage
- Self-check function
- Cobalt base magnetic ring.

### Advantages

- Stable accuracy
- Low hysteresis
- Short response time
- Compact design

### Applications

- Ground fault detection
- Converter leakage current detection
- Electric vehicle charge station
- IC-CPD
- Wallbox

### Standards

- EN 50178
- IEC 62752
- IEC 61851
- UL1741 UL508 UL94-V0

## 2. Absolute parameter

### Absolute maximum ratings

Parameter	Symbol	Unit	Min	Typ	Max
Supply voltage	V <sub>c</sub>	V			5.5
Ambient operating temperature	T <sub>A</sub>	°C	-40		105
Ambient storage temperature	T <sub>A</sub>	°C	-40		105

Stresses above these ratings may cause permanent damage. Exposure to absolute maximum ratings for extended periods may degrade reliability.

### Isolation parameters

Parameter	Symbol	Unit	Value
RMS voltage for AC test 50Hz/1min	V <sub>d</sub>	kV	3
Impulse withstand voltage 1.2/50μs	V <sub>w</sub>	kV	7
Lightning surge current 8/20μs	I <sub>LS</sub>	kA	5
Comparative tracking index	CTI	V	600
Application example	-	V	600,CAT III,PD2

### 3. Electrical data

at  $T_A = 25^\circ\text{C}$ ,  $V_C = 5\text{ V}$ .

Parameters	Symbol	Unit	Min	Typ	Max	Remark
Supply voltage	$V_C$	V	4.9	5	5.1	
Current consumption	$I_C$	mA		25	30	
Output voltage (Check function)	$V_{CK}$	V		$V_C$		
Check current	$I_{CK}$	mA		30		
Check enable voltage	$V_{CE}$	V	3.3		$V_C$	
Check disabled voltage	$V_{CD}$	V		< 0.2		
Power on initialization	$t_{on}$	ms			60	
Primary nominal RMS current	$I_M$	A		42		

## 4. Application information

### Self-check Function

When the main circuit is not working, the system leakage current is 0, the  $V_{out}$  = Low level ( 0v ).  
 (a) .when the CHK PIN is placed at high level (3.3~5V),  $V_{out}$  rises from Low level to high level(  $V_{cc}$  );  
 (b) .when the CHK PIN is placed at low level (< 0.2V), the self-generated the  $V_{out}$  drops to Low level ( 0v ).  
 When the above (a) and (b) are completed, the leakage current sensor is judged to have normal function.  
 When the self-check function is not used, add a  $0\Omega$  resistance to the CHK PIIN and ground it.

### Self-check Timing Diagram

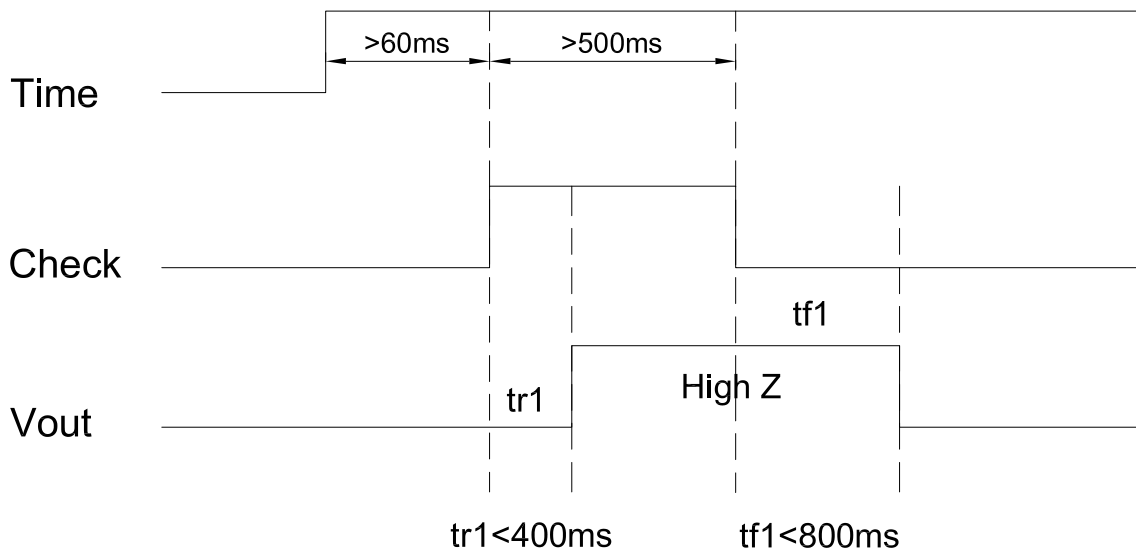

### Interrupting Time (IEC62752)

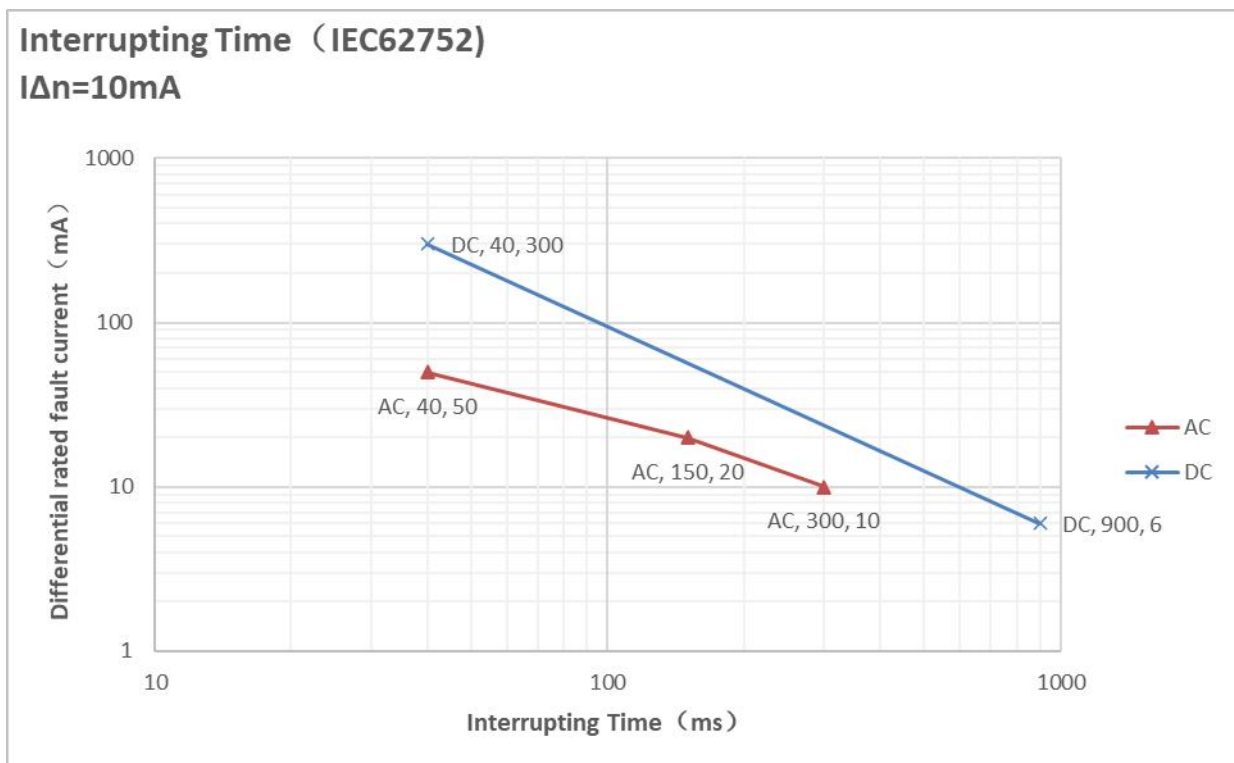

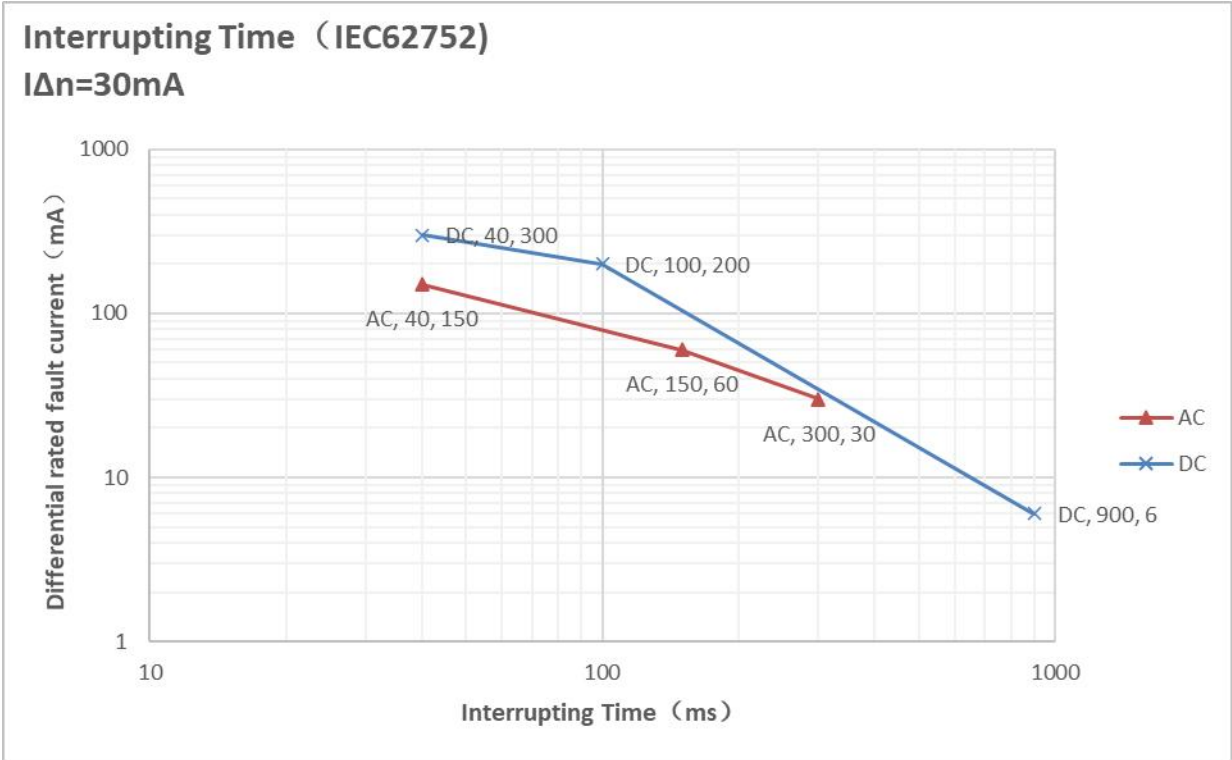

## 5. Dimensions (in mm)

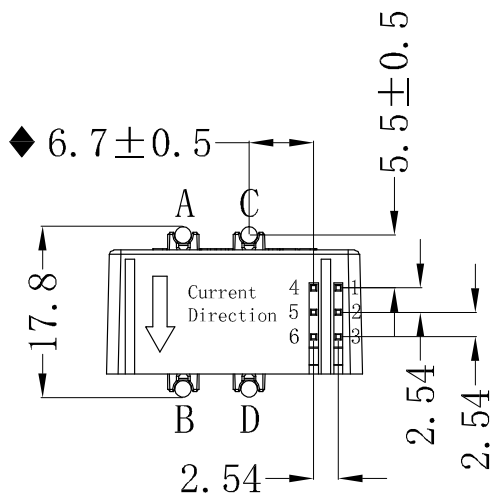
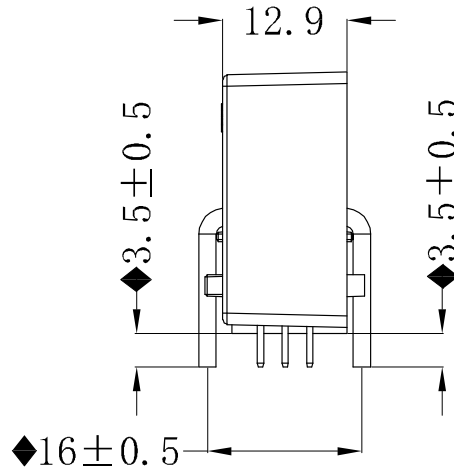
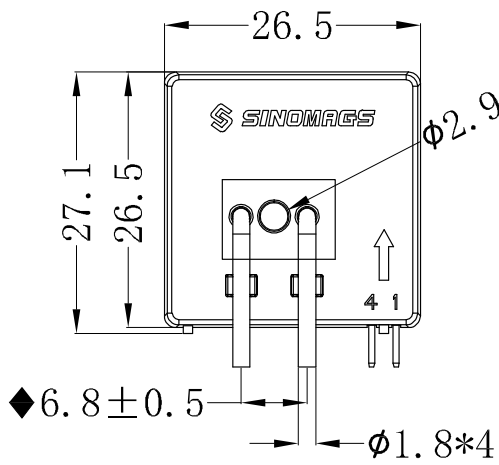

No.	Symbol	Description
1	VCC	Power supply
2	GND	Power GND
3	VO	High and low level output
4	CHK	Product Self-Check input
5	TC	NC-Float
6	RD	Version Conversion(①&②)*
A-D	IP	Primary Current

Material : Fit UL94V-0 & RoHS requirements ;  
 General tolerance :  $\pm 0.5$   
 Unit :mm

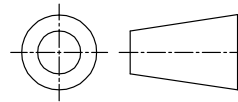

### Pin Definition

No.	Symbol	Description
1	VCC	Power supply
2	GND	Power GND
3	Vo	High and low level output
4	CHK	Product Self-Check input
5	TC	NC-Float
6	RD	Version Conversion(①&②)*
A-D	IP	Primary Current

\*Note:①:The default version( $I_{\Delta} 30\text{mA}$ );

②:Connect 1K resistance to ground version ( $I_{\Delta} 10\text{mA}$ ).